

Article number: 2302065641
 Description: E+G Three-arm knob
 VB.639/63 FP-M10

Measures

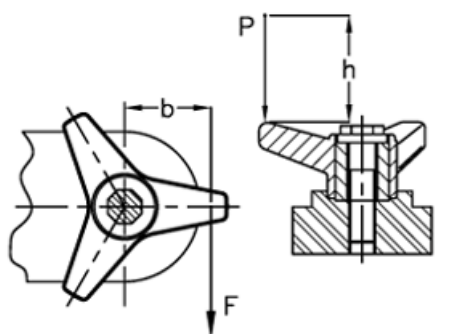
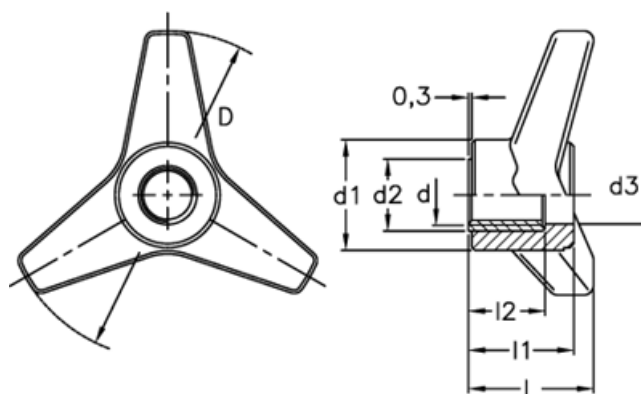

$$C[N \cdot m] = F[N] \cdot b[m] \quad L[J] = P[N] \cdot h[m]$$

C (N m) = 30
 D = 63
 d1 = 27
 d2 = 16
 d3 = 13
 d 6H = M10
 L = 29
 L(J) = 7

l1 = 25
 l2 = 21